

# WAVE



## nicoline

Descrizione modello / Model Description

Dimensioni / Dimensions

Composizioni consigliate / Suggested compositions

[nicoline.it](http://nicoline.it)

ITALY - C.da Parchi Calia sn Z.I. - 70022 Altamura - BA - Telefono: +39 080 3101487

UNITED STATES - Nicoline Salotti Inc. po box 38783 - Greensboro - NC 27438 - Phone: +1 (336) 259 9881

SINGAPORE - 23 Genting Road #06-01 - Chevalier House Singapore 349481 - Telefono: +65 8168 3354

## Descrizione

### Caratteristiche standard

- Struttura in legno e multistrato, molleggio seduta con cinghie elastiche.
- Imbottiture, in poliuretano espanso ecologico a cellula aperta con densità differenziate.
- Rivestimento in pelle o tessuto. Tutti i rivestimenti sono fissi.
- Braccioli e schienali dotati di meccanismo a snodo che si ripiega sia verso l'esterno che verso la parte interna.
- Piede in metallo Canna di fucile (Cod.50). Bronzo anticato (Cod.52), entrambe le finiture hanno la parte inferiore verniciata in colore oro satinato.
- Cucitura Cod.03 per rivestimento in pelle, sulle parti verticali della spalliera, braccio e cuscinetto lombare.
- Cucitura Cod.01 sulle parti perimetrali.
- Cucitura Cod.03 per rivestimento in tessuto.
- Inserimento letto non possibile.
- Lato componibile rifinito.

### Caratteristiche optional su richiesta senza maggiorazione

- Disponibile con cucitura a contrasto, per la scelta del colore fare riferimento ai codici del campionario pelli.
- Nessuna maggiorazione in caso di scelta dei laccetti in pelle di un colore differente dal rivestimento principale.

### Caratteristiche optional su richiesta con maggiorazione

- Per il multi rivestimento il prezzo va incrementato del 7%.
- Per maggiori dettagli fare riferimento al paragrafo "NOTE" posto nelle prime pagine del listino.

### Note

- I laccetti possono essere realizzati solamente in pelle.
- I disegni grafici che riportano l'asterisco (\*) sono sempre con lato rifinito e anche agganciabili agli elementi componibili.
- Le dimensioni indicate, sono da considerarsi al massimo ingombro (schienale e bracciolo alla massima estensione di apertura).
- Non è possibile applicare altre cuciture.
- Per alcuni tessuti e velluti l'azienda si riserva di applicare la cucitura Cod.00 (vedi immagine).

## Description

### Standard features

- Frame: wooden structure, seat suspensions in reinforced elastic webbing.
- Paddings in eco-friendly open cell polyurethane foam, with different densities.
- Covering in leather or fabric. Not removable coverings.
- Armrests and backrests equipped with junction mechanism that folds outwards and inwards.
- Legs in Gunmetal (Cod.50), Antique Bronze (Cod.52), both finishes with lower part painted in matte gold color.
- Stitching type Cod.03 on the vertical parts of the backrest, armrest and lumbar cushion.
- Stitching Cod.01 on the perimeter parts.
- Stitching type cod.03 only for fabric covering.
- Folding bed not available.
- Sectional sides are finished.

### Optional features available upon request with no upcharge

- Stitching, unless differently requested, will be matching the leather or fabric color. Contrast stitching color can be ordered at no extra charge. You might use as reference any Nicoline leather.
- No upcharge in case of choice of leather laces in a different color from the main covering.

### Optional features available upon request with an upcharge

- 7% upcharge for combined coverings or patterned fabrics.
- Please refer to the notes at the beginning of pricelist.

### Notes

- **The laces can only be made of leather.**
- Versions with asterisk (\*) have always the terminal side finished with the possibility to be connected to modular elements.
- The mentioned dimensions are to be considered as maximum overall dimensions (backrest and armrest at maximum opening extension).
- Different stitchings not available.
- For some fabrics and velvets production dept. must apply the stitching Cod.00 (as per picture below).

FRONTALE  
FRONT

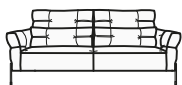

LATERALE  
DEPTH

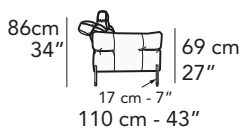
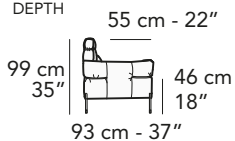

17 cm - 7"

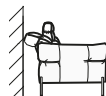

FRONTALE  
BRACCIOLO

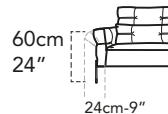

FRONTAL  
ARMREST

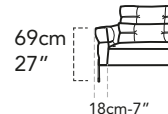

**3200**

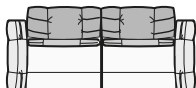

250 cm - 98"

**3000**



230 cm - 91"

**2200**

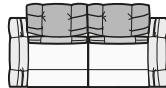

210 cm - 83"

**A**

**1203**



92 cm - 36"

**1202**



115 cm - 45"

**1201**



115 cm - 45"

**3002**

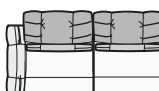

207 cm - 81"

**3001**



207 cm - 81"

**3003**

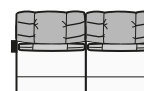

184 cm - 72"

**1602**

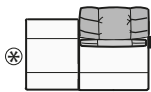

165 cm - 65"

**1601**

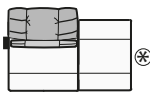

165 cm - 65"

**1572**

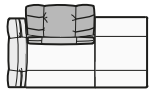

188 cm - 74"

**1571**

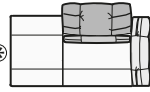

188 cm - 74"

**5202**

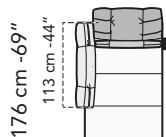

115 cm - 45"

**5201**

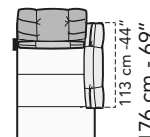

115 cm - 45"

**5203**

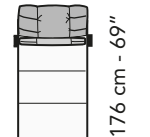

92 cm - 36"

tutti gli elementi del gruppo A hanno lo stesso modulo di seduta - all items in group A have the same seat width

**B**

**1003**



82 cm - 32"

**1002**



105 cm - 41"

**1001**



105 cm - 41"

**2202**

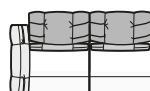

187 cm - 74"

**2201**

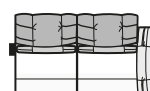

187 cm - 74"

**2203**



164 cm - 65"

**1592**

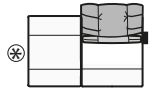

155 cm - 61"

**1591**

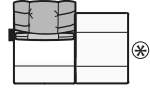

155 cm - 61"

**1552**

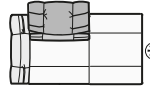

178 cm - 70"

**1551**

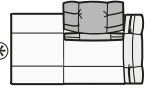

178 cm - 70"

**5002**

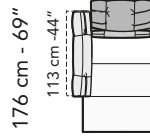

105 cm - 41"

**5001**

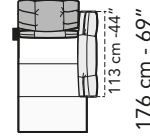

105 cm - 41"

tutti gli elementi del gruppo B hanno lo stesso modulo di seduta - all items in group B have the same seat width

**1572 + 3001**

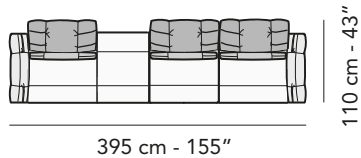

**2062 + 2051**

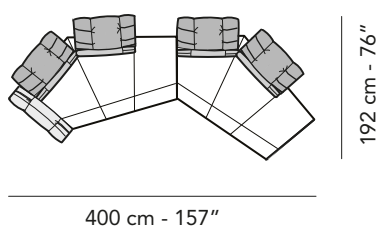

**3002 + 4024 + 1601**

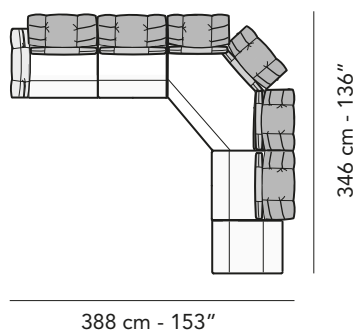

## Composizioni consigliate / Suggested compositions

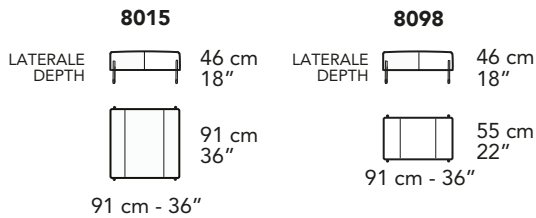
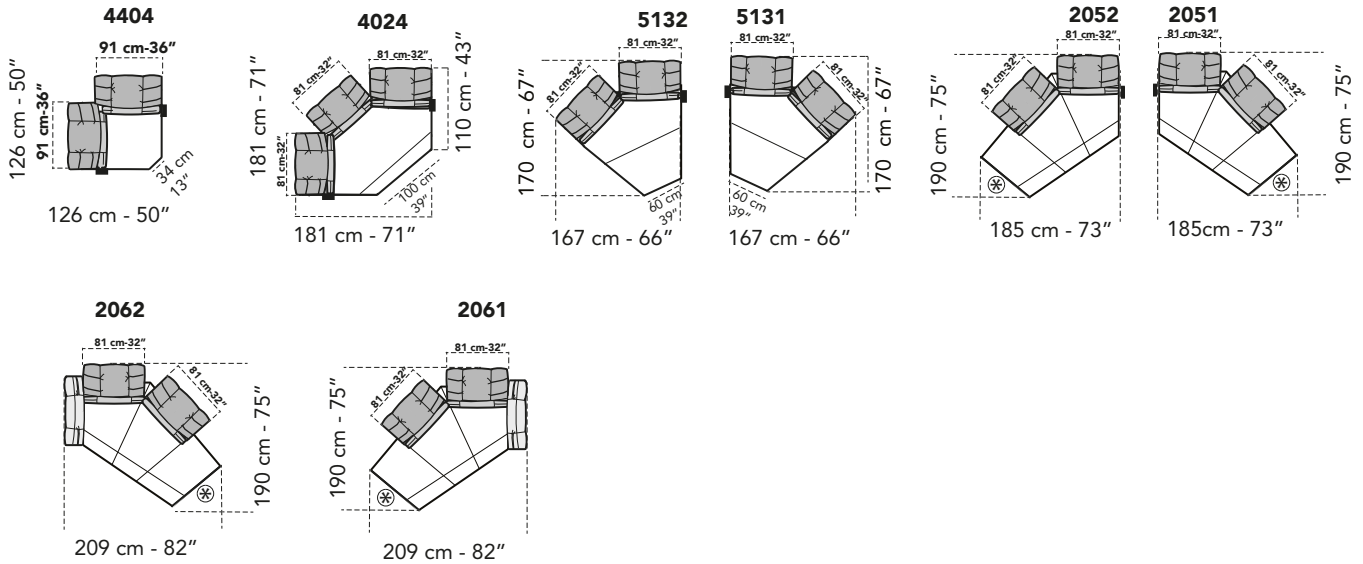

Le dimensioni indicate ,sono da considerarsi di massimo ingombro( schienale e bracciolo alla massima estensione di apertura).  
The mentioned dimensions are to be considered as maximum overall dimensions (backrest and armrest at maximum opening extension).